

DUAL GLAZE PROFILES
AVAILABLE IN 1-3/8" & 1-3/4" THICK SASH

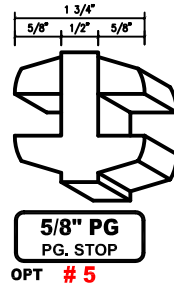

DUAL GLAZE 1 1/4" WIDE PROFILES

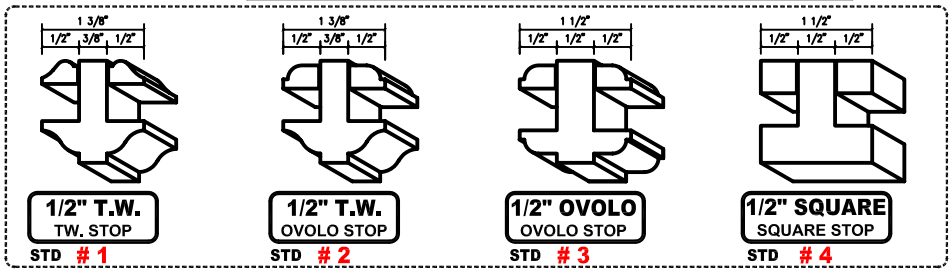
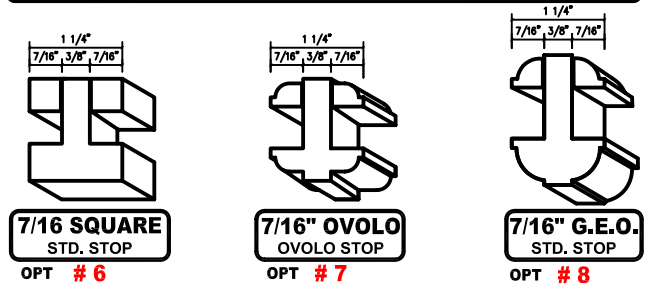

SINGLE GLAZE PROFILES
AVAILABLE IN 1-3/8" & 1-3/4" THICK SASH

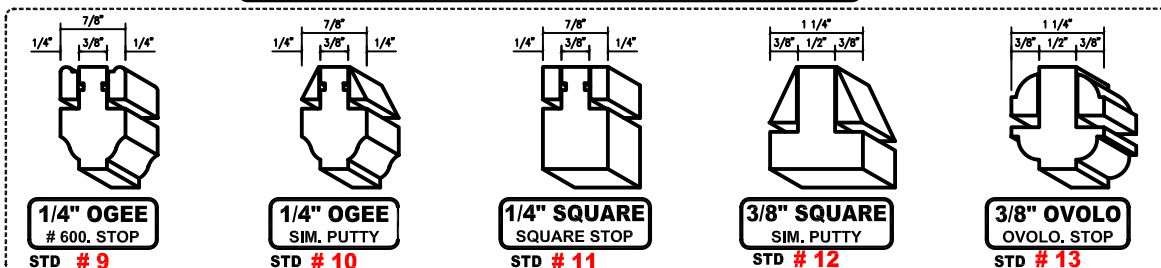

DUAL GLAZE THICKER GLASS PROFILES

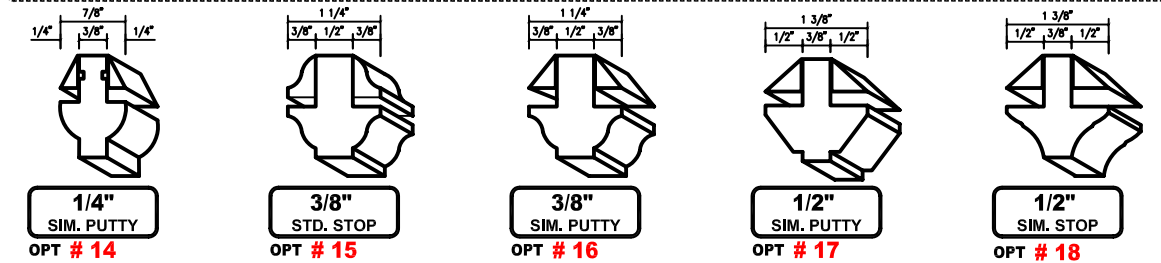
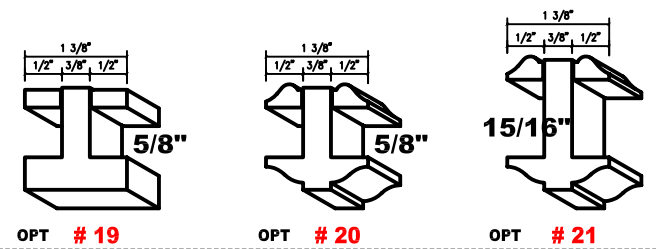

DUAL GLAZE S.D.L. PROFILES

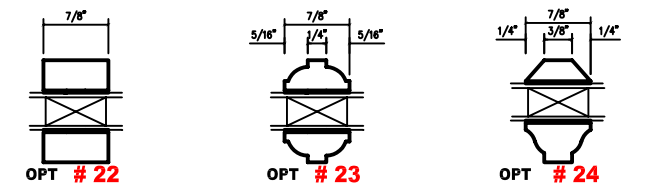

FLAT SILL APPLICATIONS

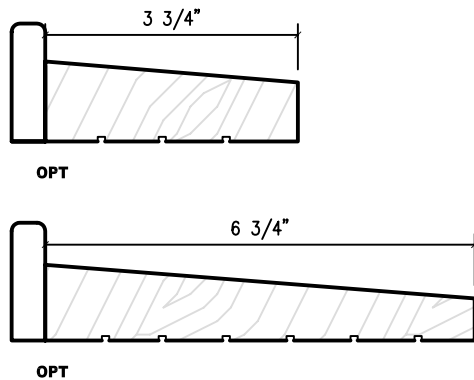

SLOPE SILL APPLICATIONS

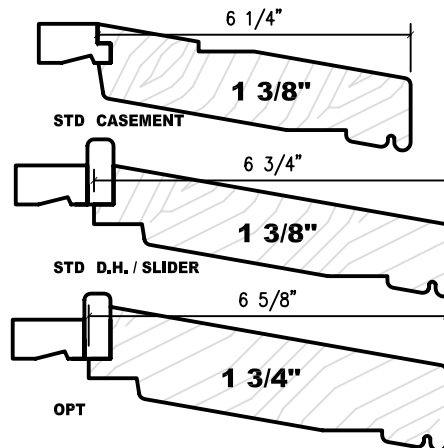

EXTERIOR Moulding Profiles

